

Appendix A1

Floor - Table of Difficulty

To get the Difficulty value for the element it must fulfil all the difficulty requirements for the specific element

1 Balances

The text contains the definition of the element and the picture is a guideline

1.1 A Dynamic Balances - Pirouettes

















The Pirouette must be performed on one foot, on toes. The turn must not be done by jumping, but a slight hop to maintain balance during the pirouette is allowed. The rotation must be totally fulfilled, measured at the hips. The tolerance for any under or over rotation at the start and/or the end of an element is 45° in total.

Optional placement of the free leg and arms. The free leg can be straight or bent but must be same for the whole team. The position of the supporting leg, bent/straight, does not change the DV, but must be the same for the whole team. The number of turns and height of the free leg define the value of the element.

A pirouette starts when the free leg and the heel is lifted from the ground and is finished when the rotation is over, the heel of the supporting leg touches the floor or the free leg touches the floor. The body shape must be correct, no leaning/arching (15° tolerance). The leg separation requirement must be fulfilled (15° tolerance) and the free leg must be held in the correct position for at least ¾ of the rotation. Showing additional flexibility does not affect the difficulty value. All gymnasts must start the turn facing the same direction, according to the choreography. No need to perform pirouettes with the same leg.

A forward pirouette means turning in the same direction to the supporting leg.

A backward pirouette means turning in the opposite direction to the supporting leg.

Pirouettes	0.2	0.4	0.6	0.8	1.0
Forwards	DB201   360°		DB601   540°	DB801   720°	DB1001   900°
Backwards	DB202   360°		DB602   540°	DB802   720°	DB1002   900°

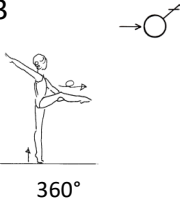
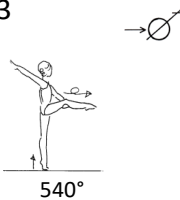
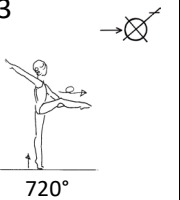
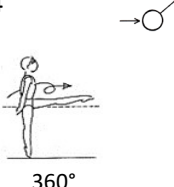
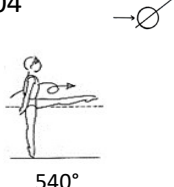
Pirouettes continued	0.2	0.4	0.6	0.8	1.0
<p>Forwards Free leg with hand support 90°. When the free leg is bent the heel is used to define the angle to the hip.</p>		<p>DB403 </p> <p>360°</p>		<p>DB803 </p> <p>540°</p>	<p>DB1003 </p> <p>720°</p>
<p>Forwards Free leg without hand support 90°. When the free leg is bent the heel is used to define the angle to the hip.</p>			<p>DB604 </p> <p>360°</p>		<p>DB1004 </p> <p>540°</p>









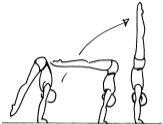
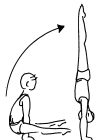
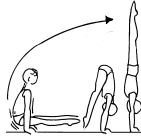

1.1 B Dynamic Balances - Power Elements

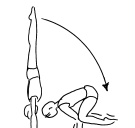
Handstand as a starting or ending position must have straight arms (45° tolerance), straight legs together (15° tolerance) and straight hips.

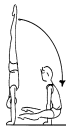
There must be a controlled and continuous movement showing dynamic strength. The movement must be performed by using muscle power, not by the gravity (not too fast lowering). No pause ≥ 3 sec allowed. No fall or more than one step allowed. E.g. in lowering from the handstand to straddle pike sitting must be slower than just gravity taking the gymnast down. Starting and ending positions must be clearly visible, but do not need be held for two seconds. All gymnasts perform the same power element with arms and legs in the same position. The body position must be according to the definition of the element, e.g. straight arms and legs together when required.











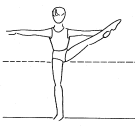
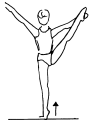

No supportive weight on the legs during the power elements.

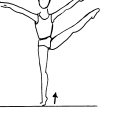
Power Elements	0.2	0.4	0.6	0.8	1.0
Press up to handstand With split straight legs (DB805). Starting position is optional.				DB805 	
Press up to handstand With straight legs together (DB1006). Starting position is optional.					DB1006 
Press up to handstand from straddle pike sitting support From a straddle pike sitting support press to handstand with straight legs.					DB1007 
Press up to handstand from pike sitting support From a pike sitting support press to handstand. Bending legs in the first part is allowed, after passing the hands, press to handstand is performed with straight legs together or straight split legs.					DB1008 

Power Elements continued	0.2	0.4	0.6	0.8	1.0
Headstand to planche From a controlled headstand, body straight, lowering to a planche on elbows. Legs together and straight (not in DB409).		DB409  headstand to frog	DB609  headstand to planche		
From handstand to support From a controlled handstand, to a "frog"/ a planche (body straight) on elbows/ a planche with straight arms. Legs straight (not in DB610). Legs may be separated.			DB610  handstand to frog		DB1010  handstand to planche
From handstand to straddle pike or pike sitting support Lowering from handstand to straddle pike/ pike sitting support. Legs must be straight the whole way.				DB811 	DB1011  legs together
Circles The turn is measured from the legs. The tolerance for any under or over rotation at the start and/or the end of an element is 45° in total. Legs and feet must be off the ground.			DB612  double leg circles 1 round	DB812  double leg circles ≥2 rounds	DB1012  flared leg circles 2 rounds
Russian wendel-swing The full turn (360°) is measured from the shoulders. The tolerance for any under or over rotation at the start and/or the end of an element is 45° in total. Legs and feet must be off the ground.					DB1013 

1.2 Standing Balances

There must be a recognised shape when performing balances on one leg. The whole body must be held in a static position for at least two seconds without any additional choreographed movements. In case the body or part of the body like an arm is moving slightly, but the elevated leg is kept in the required position and the supporting leg is not moving, the difficulty is still given. Leg separation and legs straight (not applicable to lifted leg in SB404) requirements need to be fulfilled (15° tolerance). Showing additional flexibility does not affect the difficulty value. For upright body position the central line along the length of the torso may be no more than 30° from vertical. For straight body position the tolerance is 20°. For horizontal body position the tolerance is 15°. When the free leg is bent (forward/side) the heel is used to define the angle to the hip. If not otherwise mentioned the placement of arms is optional for the team. The supporting leg needs to be straight (15° tolerance). The body position must be according to the definition of the element, e.g. upright body position, upper body at horizontal, straight body position, straight legs and standing on tiptoes when required.

Standing Balances	0.2	0.4	0.6	0.8	1.0
Side balance with help of hand Free leg on the side with help of hand. Body in upright position. Leg separation/tiptoes position defines the element. In SB1001 the free leg is held using one hand, two hands or arm. The whole team needs to hold the free leg in the same way.			SB601  120°	SB801  120° on tiptoes	SB1001  180°
Side balance without help of hands Free leg on the side without help of hand. Body in upright position. Leg separation/ tiptoes position defines the element.		SB402  90°		SB802  120°	SB1002  120° on tiptoes
Frontal balance Free leg in front with help of hand/hands. Leg separation/ tiptoes position defines the element. Body in upright position.			SB603  120°	SB803  120° on tiptoes	
Frontal balance Free leg in front without help of hand/ hands. Leg separation/ tiptoes position defines the element. In SB404 the toe is placed on the knee. Body in upright position.	SB204  90°	SB404  on tiptoes	SB604  90° on tiptoes	SB804  120°	SB1004  120° on tiptoes

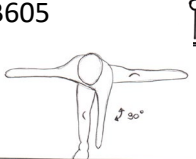
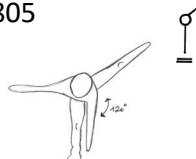
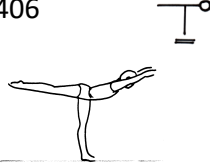
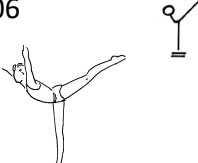
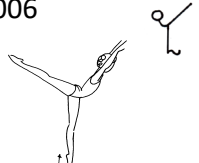
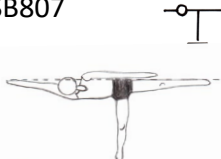
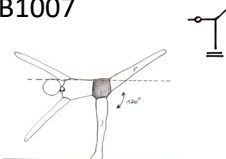
Standing Balances continued	0.2	0.4	0.6	0.8	1.0
<p>Side balance Upper body at horizontal, free leg to the side. Heel defines the angle to the hip. Leg separation defines the element.</p>			<p>SB605</p>  <p>90°</p>	<p>SB805</p>  <p>120°</p>	
<p>Scale Upper body must be horizontal or above. Leg separation/tiptoes position defines the element.</p>		<p>SB406</p>  <p>90°</p>		<p>SB806</p>  <p>120°</p>	<p>SB1006</p>  <p>120° on tiptoes</p>
<p>Scale sideways without help of hand Upper body must be horizontal (body position is measured from the upper side of the torso, 15° tolerance) In SB807 the upper body and the leg must stay in the frontal plane. Leg separation defines the element (measured from the heel). The hip must be extended, upper body not twisted. (15° tolerance)</p>			<p>SB807</p>  <p>90°</p>	<p>SB1007</p>  <p>120°</p>	

1.3 Hand Supportive Balances

In a hand supportive balance, the body is held in a static position for at least two seconds. Only the hands are touching the floor (except in headstand HB201 and forearm balance HB601). There must be a recognised shape without any additional movement. The hip angle, straight legs and leg separation/legs together requirement must be fulfilled (15° tolerance). Showing smaller hip angle does not affect the difficulty value. Body must be straight according to the definition of the element (30° tolerance). The body line must be horizontal according to the definition of the element (20° tolerance).

In case the body or part of the body like the legs are moving slightly, but the hands are not moving, the difficulty is still given.

Leaning on the arms is not allowed in pike sitting supports where the legs are lifted over the horizontal level.

In handstand HB1001, the team need to have the legs in the same position and above hip level. No need to have straight legs together.

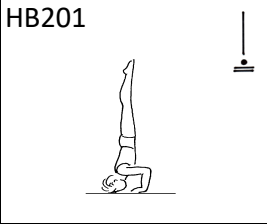
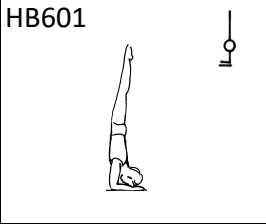
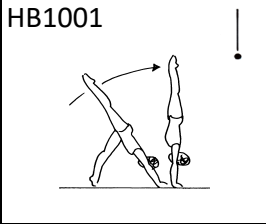
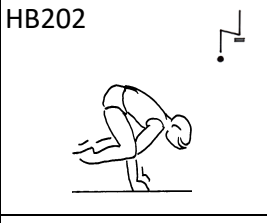
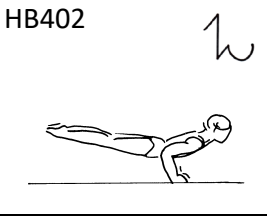
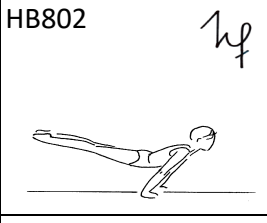
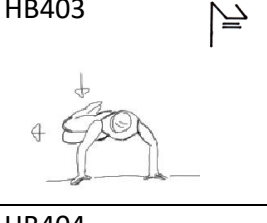
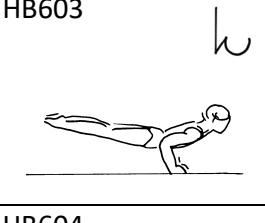
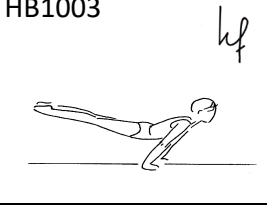
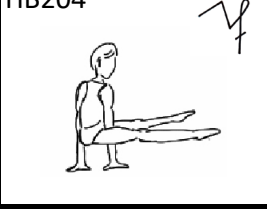
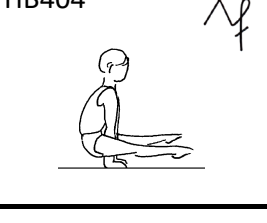
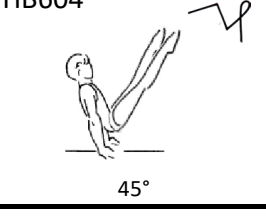
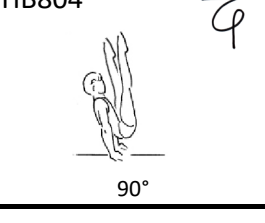
Hand Supportive Balances	0.2	0.4	0.6	0.8	1.0
Headstand/Handstand In HB201 head is allowed on floor, straight legs together. In HB601 no leaning on head, straight legs together. In HB1001 the arms must be straight (45° tolerance) and the legs above hip level. The placement of legs must be the same for the whole team (45° tolerance on the posture and position of legs).	HB201 		HB601 		HB1001 
Planche on elbows/straight arms, legs separated Straight legs (except HB202). Leg separation 45°. The body is supported on both hands on elbows or straight arms. Hands may be turned out at the wrist or pointing towards the feet. The body line horizontal (not in HB202). When performing HB802, arms must be straight (15° tolerance).	HB202 	HB402 		HB802 	
Planche on elbows/straight arms, legs together Straight legs together (except HB403). The body is supported on both hands (except HB403) on elbows or straight arms. Hands may be turned out at the wrist or pointing towards the feet. The body line horizontal. When performing HB1003, arms must be straight (15° tolerance).		HB403 	HB603 		HB1003 
Straddle pike sitting-support Straight legs. Hands placed in front or back (HB404) or front and back (HB204), leg separation 45°. Leaning on arms is not allowed when legs are lifted higher than parallel to the floor. Both hands are placed at the side of the body, close to the hips. Body is supported with only the hands in contact with the floor.	HB204 	HB404 	HB604  45°	HB804  90°	

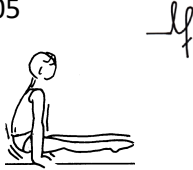
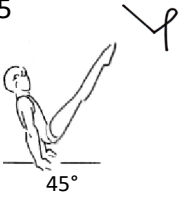
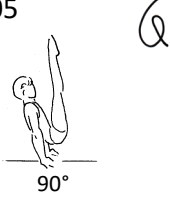
Hand Supportive Balances continued	0.2	0.4	0.6	0.8	1.0
<p>Pike sitting- support Straight legs together. When legs are lifted higher than parallel to the floor no leaning on the arms is allowed. Both hands are placed at the side of the body, close to the hips. Body is supported only with the hands in contact with the floor.</p>		<p>HB405</p> 		<p>HB805</p>  <p>45°</p>	<p>HB1005</p>  <p>90°</p>









2 Jumps, including Leaps and Hops (J)











The text contains the definition of the element and the picture is a guideline





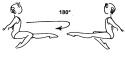

A recognised body shape (position) must be shown in the air. E.g. straight arms and legs, straight shoulder angle and correct body line when required.
 The shape during flight, twisting and landing must be according to the definition of the element. If not otherwise mentioned, the placement of the twist is optional, but all gymnasts must perform the same variation.
 The leg separation/legs together and hip angle (15° tolerance). The tolerance for any under or over rotation at the start and/or the end of an element is 45° in total. Showing additional flexibility or smaller hip/knee angles does not affect the difficulty value. In the take-off and landing, the hip defines the degree of the turn/twist.
 The whole team must perform the same jump with arms and legs in the same position. If not otherwise mentioned, the placement of arms is optional for the team.
 When landing in front laying support the body must be horizontal before landing (20° tolerance). That means that shoulders, hips and heels are all on the same level.
 When performing with the foot at shoulder/head height, the lowest part of the foot defines height. The whole foot (both heel and toes) must be at the required height. Head height: The point where the neck reaches the base of the skull or above. Shoulder height: Above the top of the shoulder.
 No more than three steps (walking or running) are allowed before any jump, according to the choreography.
 In jumps with twists all gymnasts must start the jump facing the same direction, according to the choreography. (Valid only in jumps, not in leaps and hops).

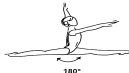







2.1 Jumps











A Jump takes off from two feet and lands on two feet (a) or lands on one foot (b) or in front laying support c)





2.1A Jumps starting and landing with two feet	0.2	0.4	0.6	0.8	1.0
Stretched jump with twisting Straight body during the flight. Twist finished in the air. Placement of arms is optional.		J401  360°	J601  540°	J801  720°	
Tuck jump with twisting Tucked position (hip and knee angle 90°, 15° tolerance) visible during the jump. Twist completed in the air. Placement of arms is optional.				J802  360°	J1002  540°
Straddle pike jump with or without twisting Leg separation 135° and clear pike 90° (15° tolerance in leg separation and hip angle) legs straight without a kick.			J603  180°	J803  360°	J1003  360°



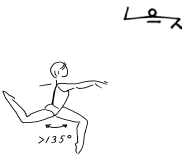

2.1A Jumps starting and landing with two feet	0.2	0.4	0.6	0.8	1.0
Sheep jump Head back. Height of the feet defines the jump. Legs may be separated. No tolerance in feet height.				J804  Feet at shoulder height	J1004  Feet at head height
Sheep jump twisted The feet must reach the shoulder height somewhere during the jump. No tolerance in height of feet. Twist must be performed during the flight.					J1005  Twist 180°
Double stag jump with or without twisting Right 'stag'-position must be visible during the jump: both legs bent 90°, leg separation 135° (15° tolerance), height of the rear foot or twists defines the element. No tolerance in foot height. The turn must be fulfilled during the flight.	J206  $>135^\circ$	J406  180°			J1006  Double stag ring Foot at head height
Wolf jump with or without twisting One leg extended, other tucked. Hip and bent knee angles 90° (15° tolerance). When twisting, the turn must be performed during the flight.	J207  	J407  180°		J807  360°	
Split jump In J408 and J1008 both legs must be straight, no kick. Leg separation defines the jump.		J408  Leg separation 135°			J1008  Leg separation 180°

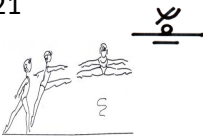
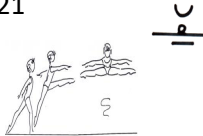
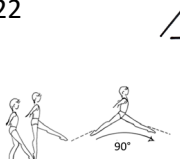
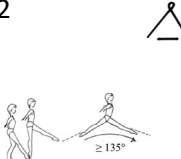
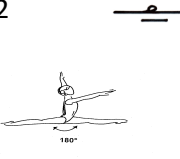
2.1B Jumps starting with two feet and landing on one foot	0.2	0.4	0.6	0.8	1.0
Sissone Front leg minimum at 45° (no tolerance). In J1009 A/B no tolerance in foot height.		J409  Leg separation 135°		J809  Leg separation 180°	J1009 A/B  Foot at head height J1009A without twist J1009B with 180° twist
Double stag jump with or without twisting Right 'stag'-position must be visible during the jump: both legs bent 90°, leg separation 135° (15° tolerance), height of the rear foot or twists defines the element. No tolerance in foot height. The turn must be fulfilled during the flight.	J210  $>135^\circ$	J410  180°			J1010  Double stag ring Foot at head height

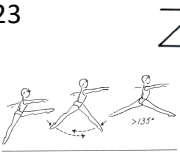
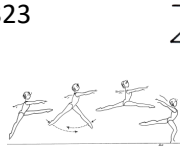
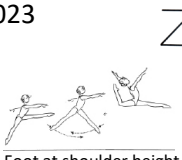
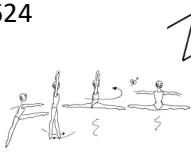
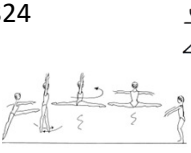
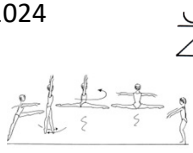
2.1C Jumps starting with two feet and landing in front laying support	0.2	0.4	0.6	0.8	1.0
Tuck jump with or without twisting to front laying support Tucked position (hip and knee angle 90°, 15° tolerance) visible during the jump. When twisting 180° turn must be completed before tucked position. When twisting 360° or more turn must be ready before landing. Body must be horizontal before landing.		J411 	J611  180°	J811  360°	
Shushunova with or without twisting Leg separation 135° and clear pike 90° (15° tolerance in leg separation and hip angle) before landing in front laying support. Body must be horizontal before landing. When twisting the turn must be performed during the flight.			J612  180°	J812 A/B  J812A=180° J812B=360°	
Pike jump to front laying support with or without twisting Clear pike 90° (15° tolerance) before landing in front laying support, straight legs together. Body must be horizontal before landing. When twisting, the turn must be performed during the flight.			J613  180°	J813 A/B  J813A= twist 180° J813B= twist 360°	
Split jump landing to front laying support Legs must be straight, no kick. Leg separation defines the jump. Body must be horizontal before landing.			J614  Leg separation 135°	J814  Leg separation 180°	

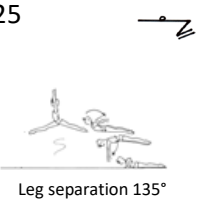
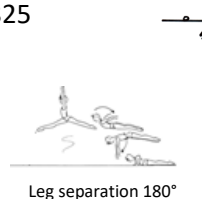
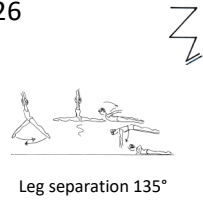
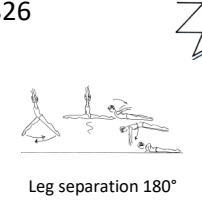
2.2 Leaps A Leap takes off from one foot and lands on the other (a) or both feet (b) or front laying support (c) (exceptions: switch leaps in rows 23 and 24)					
2.2A Leaps starting on one foot and landing on the other	0.2	0.4	0.6	0.8	1.0
Stretched leap with twisting Body straight during the flight. Twist finished in the air. Placement of arms is optional.		J415  360°	J615  540°		
Cat leap twisting Bent legs. Leg change during the flight. Thighs must be horizontal (no tolerance) somewhere during the flight. The turn must be fulfilled in the air.			J616  360°	J816  540°	J1016  720°
Scissors leap Straight legs. Leg change during the flight. First leg must reach horizontal (no tolerance).			J617  Leg separation 135°		
Scissors leap 180° (Entrelacé) Straight legs. Leg change during the flight. First leg must reach horizontal (no tolerance). Twisting during the flight. Leg separation after the turn defines the element.		J418  Leg separation 90°		J818  Leg separation 135°	J1018  Leg separation 180°
Butterfly legs separated, upper body at horizontal, legs above horizontal level (no tolerance) A stomach upwards B stomach downwards					J1019A/B  Butterfly fw or bw

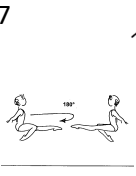
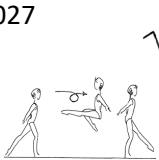
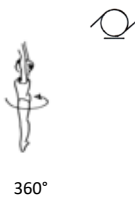







2.2A Leaps starting on one foot and landing on the other	0.2	0.4	0.6	0.8	1.0
Double stag leap Right 'stag'-position must be visible during the leap: both legs bent 90°, leg separation 135° (15° tolerance), height of the rear foot or twists defines the element. No tolerance in foot height.		J420 		J820  Double stag ring Foot at head height	
Split leap to straddle pike position with twisting Leg separation 135°, clear pike 90° and legs straight without a kick.			J621  Leg separation 135° twist 90°	J821  Leg separation 135° twist 180°	
Split leap forward In J222, J422 and J822 both legs must be straight, no kick. Leg separation defines the leap. In J1022 horizontal ring-leap: first leg straight and horizontal, foot at shoulder level or higher (no tolerance).	J222  Leg separation 90°	J422  Leg separation 135°		J822  Leg separation 180°	J1022  Leg separation 180°
Switch leap In J623 and J823 both legs must be straight, no kick. First leg must swing forwards at least 45° before the leg change. Leg separation after leg change defines the leap. In J1023 first leg must be straight. Foot must be at shoulder level or higher (no tolerance).			J623  Leg separation 135°	J823  Leg separation 180°	J1023  Foot at shoulder height leg separation 180°
2.2B Leaps starting on one foot and landing on two feet	0.2	0.4	0.6	0.8	1.0
Switch leap twisting Both legs must be straight, no kick. First leg must swing forwards at least 45° before the leg change. Leg separation after leg change defines the leap. Twist must be finished during the flight.			J624  Leg separation 135° twist 90°	J824  Leg separation 135° twist 180°	J1024  Leg separation 180° twist 180°



2.2C Leaps starting with one foot and landing in front laying support	0.2	0.4	0.6	0.8	1.0
Split leap forward landing to front laying support Legs must be straight, no kick. Leg separation defines the value of the leap. Body must be horizontal before landing.			J625  Leg separation 135°	J825  Leg separation 180°	
Switch leap to front laying support Both legs must be straight, no kick. First leg must swing forwards at least 45° before the leg change. Leg separation after leg change defines the leap. Body must be horizontal before landing.			J626  Leg separation 135°	J826  Leg separation 180°	
2.3 Hops					
A Hop takes off from one foot and lands on the same foot.					
	0.2	0.4	0.6	0.8	1.0
Wolf hop with or without twisting One leg extended, other tucked. Hip and bent knee angles 90° (15° tolerance). When twisting, the turn must be performed during the flight.	J227 	J427  180°			J1027  360°
Stretched hop with twisting Body straight during the flight. Twist finished in the air. Placement of arms is optional.				J828  360°	J1028  540°
Tuck hop with twisting Tucked position (hip and knee angle 90°, 15° tolerance) visible during the jump. Twist finished in the air. Placement of arms is optional.					J1029  360°







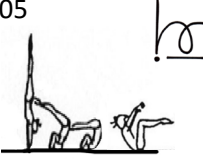

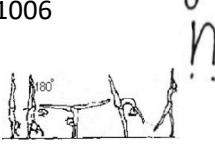

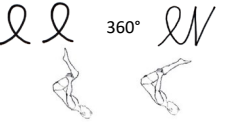

3 Acrobatic Elements

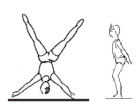

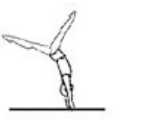
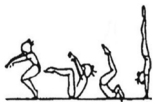

The text contains the definition of the element and the picture is a guideline





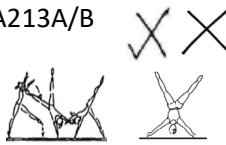

Acrobatic elements must comply with norms of TeamGym. Arms, legs and shoulder angle must be straight when required. Body shape must be according to the elements definition. Different landing positions are allowed as long as they are feet first (in absence of any other description). In elements with a twist the tolerance is 45° from the nominal twist rotation. Some elements have different variations (A/B/C). No more than three steps (walking or running) are allowed before any difficulty element, according to the choreography. In elements with turns in handstand the team needs to show the handstand (with straight arms, straight hips and straight legs together) before turning. When turning, legs can be separated (above hip level, whole team the same position). There is no need for the team to perform the turn to the same direction. The turn is measured at the hips, 45° tolerance.

3.1 Forward Elements	0.2	0.4	0.6	0.8	1.0
<p>Forward saltos from one foot to one foot Exception: A601 - landing in sitting position</p> <p>In A601 the landing in sitting position must be with hands and foot before any other part of the body.</p>			<p>A601 </p> <p>sitting salto</p>	<p>A801 </p> <p>tucked salto fwd</p>	<p>A1001 </p> <p>piked salto</p>
<p>Forward saltos from one foot to two feet</p>				<p>A802 </p> <p>tucked salto fwd</p>	<p>A1002 </p> <p>tucked salto fwd 180°</p>
<p>Forward saltos from 2 feet A version: from two feet to two feet B version: from two feet to two feet with half twist</p>			<p>A603A/B </p> <p>tucked salto/ tucked salto 180°</p>	<p>A803A/B </p> <p>piked salto/ piked salto 180°</p>	
<p>Forward handspring elements A version: from one foot to one foot B version: from one foot to two feet</p>			<p>A604A/B </p> <p>handspring</p>		<p>A1004 </p> <p>free handspring</p>

Forward Elements 3.1 continued	0.2	0.4	0.6	0.8	1.0
<p>Forward roll elements Bending arms when rolling is optional for the team.</p> <p>In A605 and A1005: Feet must not touch the floor. Momentum from the forward roll is used all the way through the element. (no stop, no head on the floor)</p>	<p>A205</p>  <p>handstand to forward roll</p>		<p>A605</p>  <p>endo roll</p>		<p>A1005</p>  <p>endo roll to handstand</p>
<p>Forward walkover elements</p>		<p>A406</p>  <p>walk over forwards</p>			<p>A1006</p>  <p>handstand 180° turn to walk over fw</p>

3.2 Backward Elements	0.2	0.4	0.6	0.8	1.0
Backward saltos Take-off and landing on two feet A version: tucked/straight salto without twisting B version: tucked/straight salto with full twist C version: piked salto			A607A/B/C  Tucked/piked salto bw		A1007A/B  Straight salto bw
Backward gainer saltos A608 and A808: take-off from 1 leg, landing on 2 legs A1008: take-off from one leg, landing on the other leg			A608  Gainer salto tucked	A808  Gainer salto piked	A1008  Gainer layout
Backward elements A609 passes through handstand to finish in front support. In A809 take-off is from one leg to land on the other leg	A209  Roundoff	A409  Flic flac	A609  Flic flac to front support	A809  Gainer flic flac	
Backward roll elements Elbow flexion is optional.		A410  Backward roll to handstand		A810  Bw roll to handstand with 180° turn	A1010  Bw roll to handstand with 360° turn
Backward walkover elements		A411  Walk over bw	A611  Walk over bw from sitting (valdez)		A1011  Valdez with 360° turn in handstand

3.3 Sideways Elements	0.2	0.4	0.6	0.8	1.0
<p>Sideways salto The sideways salto can vary in terms of take off direction (between forwards and sideways with 45° tolerance), taking off/landing on one or two feet, and also body shape. However, the skill must be performed the same for the whole team.</p>					<p>A1012 </p>  <p>Sideways salto</p>
<p>Sideways elements A version: cartwheel with one hand B version: cartwheel with two hands In A213 the team may choose to use the first or the second hand in a cartwheel, but it must be the same for the whole team.</p>	<p>A213A/B </p> <p>Cartwheel with one or two hands</p>				<p>A1013 </p>  <p>Free cartwheel</p>

3.4 Mixed Elements	0.2	0.4	0.6	0.8	1.0
<p>Mixed walkover elements</p>			<p>A614 </p>  <p>Walk over fw - bw (tic toc)</p>		<p>A1014 </p>  <p>Walk over bw with 180° turn to walkover fw</p>
<p>Mixed elements</p>					<p>A1015 </p>  <p>Flic flac with 180° twist to handstand with walkover fw or to handspring</p>

4 Group Elements

The text contains the definition of the element and the picture is only for an example

All gymnasts of the team have to take part in the group element and play an active role in either a visible lift off the floor or a throw which can be done together with the whole team or in groups of at least 3 gymnasts. The group element must be performed at the same time according to the choreography, in groups or as a whole team. Different groups must perform group elements with the same code number but the elements do not need to be the same. Rotations and twists are always in reference to the gymnast(s) being lifted or thrown. (no tolerance in rotation/twist)

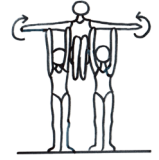
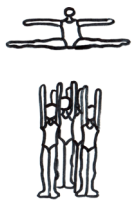
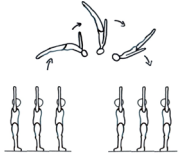
Group elements	0.2	0.4	0.6	0.8	1.0
<p>Lift In G601 the lifted gymnast(s) must be off the ground for at least 2 seconds. In G1001 the rotation/twist during the lift is measured from ground to ground.</p>			<p>G601</p>  <p>Lift</p>		<p>G1001</p>  <p>Lift with rotation or twist ($\geq 180^\circ$)</p>
<p>Throw The thrown gymnast(s) must show clear flight, free of supporting gymnasts. In G1002 the rotation/twist during the throw is measured during the free flight phase.</p>				<p>G802</p>  <p>Throw</p>	<p>G1002</p>  <p>Throw with rotation or twist ($\geq 90^\circ$)</p>

5 Flexibility Elements

The text contains the definition of the element and the picture is a guideline

All gymnasts of the team have to do the same flexibility element, which must be performed at the same time according to the choreography. In the flexibility element, the position must be clearly shown, but does not have to stay still. The legs must be straight and the leg separation requirement must be fulfilled (15° tolerance). Showing additional flexibility or smaller hip/knee angles does not affect the difficulty value. The upper body fold requirement must be totally fulfilled, no tolerance.

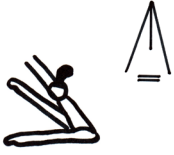
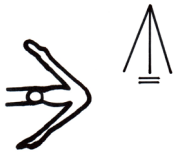
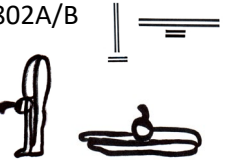
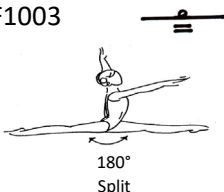
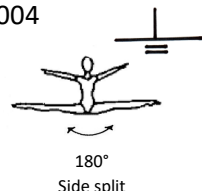
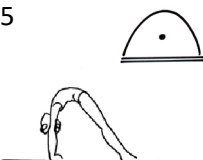
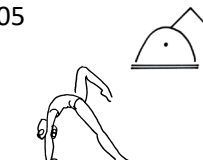
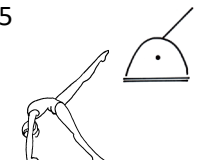
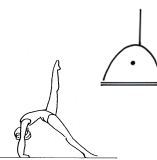
Flexibility elements	0.2	0.4	0.6	0.8	1.0
Straddle pike sitting fold Leg separation must be at least 90° F401: upper body folded 45° F801: upper body folded all the way down, chest on the floor		F401  Japana 45°		F801  Japana	
Piked fold A version: Standing B version: Sitting In piked fold the chest/shoulders must touch straight legs. Legs must be together (15° tolerance).				F802A/B  Standing/sitting pike fold	
Split with 180° leg separation The position of the upper body is optional for the team.					F1003  180° Split
Side Split with 180° leg separation The position of the upper body is optional for the team.					F1004  180° Side split
Bridge Position and angle of the free leg defines the element. Shoulders must be at least on top of the hands (as defined by a vertical straight line through the centre of the shoulders). No tolerance in free leg height.		F405 	F605  Thigh vertical	F805  Leg 45° from vertical	F1005  Leg vertical

Appendix A2

Floor - Summarised Execution Faults

1 Floor

Floor Execution Faults	Minor	Moderate	Major
1.1 Synchronisation			
Deduction if a gymnast is not synchronised with the rest of the team when intended	Gymnast about one beat ahead/after	Gymnast about two beats ahead/after (e.g., coming earlier down from a balance element)	Gymnast "lost"; performing totally different or not performing at all
1.2 Uniformity in execution			
Deduction if there are differences in performing elements meant to be the same	Small differences	Very visible differences	
1.3 Dynamic execution			
Deduction when purposeless pauses, new energy created for next elements, no gravity and relaxation used. Missing flow in the program. NOTE: When minor faults are done by the whole team the deduction will be 0.4 each time	Purposeless pauses Creating a new force for the element instead of using momentum from the previous element No flow		
Deduction if isolated arm and leg movements are performed or "frozen upper body"	Isolated arm and leg movements, "frozen upper body"		
1.4 Amplitude and extension			
Deduction if missing amplitude and/ or extension	Element performed constricted Not optimal extension in elements, e.g., not pointed feet		

Floor Execution Faults	Minor	Moderate	Major
1.5 Balance and controlled execution			
Deduction if lack of balance or control. For the specific deduction in Difficulty elements see section 1.8. Performance in difficulty elements	Extra/ contra movements, slight stepping/ hopping/ jumping to maintain balance during the element/ movement	Significant correction hop/ step to maintain balance during the element several steps or hand support	
1.6 Precision in formations			
Deduction if all gymnasts are not on exact places according to the tariff form	Gymnast out of formation		
1.7 Transitions			
Quality			
Deduction if a transition is performed simply by walking, marching, or running without the whole upper body included in the movement	Missing gymnastic quality in transition		
Easy access			
Deduction if a transition between formations is not performed by easy access	Not having easy access to a formation		

Floor Execution Faults	Groups	Minor	Moderate	Major
1.8 Performance in Difficulty Elements				
Definition of the element in this table means how the technique of the element is defined in gymnastics (e.g., cartwheel performed with straight arms and legs)				
1.8.1 Deductions for the whole Body				
Body shape must be correct according to the definition of the element				
Deduction if errors in body shape	all elements	Minor errors in body shape	Errors in body shape	Significant errors in body shape
Body must be straight according to the definition of the element				
Deduction if the body is not straight (arched/bent)	DB, HB, SB, A		Body exceeding/bending >20°	
The whole body must be held in a static position for at least two seconds				
Deduction if gymnast is moving during the element	SB, HB	Gymnast is slightly moving, supporting leg/hands not moving	Gymnast clearly moving or taking a step/hop	Taking several steps/hops
Body must be upright according to the definition of the element				
Deduction if body position is not upright	DB, SB, HB	Body leaning forward/backward/sideways ≥15°	Body leaning forward/backward/sideways >30°	
Body line must be horizontal according to the definition of the element				
Deduction if the body line is not horizontal	HB		Body line exceeding horizontal >20°	
1.8.2 Deductions for the upper body				
Upper body must be horizontal according to the definition of the element				
Deduction if upper body is not horizontal (Side balance, SBX05) or if body is above 90° (Scale sideways, SBX07)	HB, SB, J	Upper body above/below horizontal, ≤15°	Upper body above/below horizontal, >15°	
Upper body must be sideways, and hip extended according to the definition of the element				
Deduction if upper body is not sideways or hip not extended (Scale sideways, SBX07)	SB	Upper body twisted, not sideways ≤15° Hip not extended ≤15°	Upper body twisted, not sideways >15° Hip not extended >15°	

Floor Execution Faults	Groups	Minor	Moderate	Major
1.8.3 Deduction for Hips				
Hip angle must be according to the definition of the element				
Deduction for mistake in hip angle	DB, SB, HB, J	Slight mistake in hip angle $\leq 15^\circ$	Mistake in hip angle $>15^\circ$ up to 45°	Major mistake in hip angle $>45^\circ$
1.8.4 Deductions for Legs/Knees/Feet				
Legs must be straight according to the definition of the element				
Deduction if legs are not straight	all elements	Slightly bent legs $\leq 15^\circ$	Bent legs $>15^\circ$ up to 45°	Bent legs $>45^\circ$
Legs/knees must be together according to the definition of the element				
Deduction when legs are separated	all elements	Leg/knee separation $\leq 15^\circ$	Leg/knee separation $>15^\circ$ up to 45°	Leg/knee separation $>45^\circ$
Legs must be off the ground according to the definition of the element				
Deduction if legs touch the floor	DB1007, DB1008, DBX11, DBX12 and DB1013	Legs touching the floor with no supportive weight		Legs touching the floor with supportive weight
Leg separation requirement must be fulfilled according to the definition of the element				
Deduction if the leg separation requirement is not fulfilled	DB, HB, SB, J, F	Missing $\leq 15^\circ$ of required leg separation	Missing $>15^\circ$ up to 45° of required leg separation	Missing $>45^\circ$ of required leg separation
Height of the free leg must be according to the definition of the element				
Deduction if free leg is too low	DB, SB	Missing $\leq 15^\circ$ of required leg height	Missing $>15^\circ$ up to 45° of required leg height	Missing $>45^\circ$ of required leg height
Elements must be performed on toes according to the definition of the element				
Deduction if not on toes when required	DB, SB	Heel is touching the floor (no weight on the heel)	Standing on whole foot (weight on the heel)	

Floor Execution Faults	Groups	Minor	Moderate	Major
1.8.5 Deduction for Shoulders				
Shoulder angle must be straight according to the definition of the element				
Deduction if shoulder angle is not straight	HB, F	Shoulder angle >30° and up to 45°	Shoulder angle >45°	
1.8.6 Deductions for Arms/Hands				
Arms must be straight according to the definition of the element				
Deduction if arms are not straight	all elements	Slightly bent arms ≤15°	Bent arms >15° up to 45°	Bent arms >45°
No stepping with hands according to the definition of the element				
Deduction if stepping with hands during the element	DB, A	One step on hands to maintain the balance	Two or more steps to maintain the balance	
1.8.7 Deductions for Landing				
Landing must be controlled according to the definition of the element				
Deduction if mistakes on landing	J, A, G	Slight mistakes on landing (e.g., a bit unbalanced with extra movements to continue)	Heavy landing (hard to continue to the next element)	
Landing in front laying support must be according to the definition of the element				
Deduction if mistakes in landing in front laying support	J		No controlled support before whole body touches the floor, bouncing back from the floor	Body not horizontal before landing in front laying support
1.8.8 Deduction for Rotation				
The rotation must be completed according to the definition of the element. Starting and ending positions are assessed from how the gymnasts are lined up before the execution of the element. (For Pirouettes and Jumps, Appendix A1 1.1A and 2.1, the starting position is assessed from how the team are lined up.)				
Deduction if the turn/twist is not completed according to the definition of the element. Deviation from the starting/ending positions.	DB, J, A	Under or/and over rotation 30-45°	Under or/and over rotation >45° up to 90°	Under or/and over rotation >90°

Floor Execution Faults	Groups	Minor	Moderate	Major
1.8.9 Special deductions, valid only in one element group				
Pirouettes must be performed on one foot				
Deduction if performed both feet on floor	DB			Pirouette performed both feet on floor somewhere during the turn
In Power elements the movement must be controlled				
Deduction if the movement is not controlled through the element	DB		Fast lowering from the handstand, still visible ending position	Fast lowering from the handstand, no clear ending position
Power elements must be performed without a pause or a stop during the element				
Deduction if there is a pause/stop during the power element	DB	Short pause during the element (<3 s)	Stop during the element (≥3 s)	
No more than 3 steps per half turn in a handstand				
Deduction if stepping more with hands during the element	A	Too many steps (more than 3)		
Showing flexibility according to the definition of the element				
Deduction if the flexibility requirements are not fulfilled	F	Hip not straight forward in splits Back is not straight when folding down in straddle pike sitting	Hip is clearly twisted in splits Insufficient fold in straddle pike sitting	Upper body (shoulders, chest, stomach) is not touching the floor during the straddle pike sitting fold. Chest not on straight knees in pike folds

Appendix A3

Tumble - Table of Difficulty

Diff Value	Group 1 Forward elements	Artistic Code	K Code	Diff Value	Group 2 Backward elements	Artistic Code	K Code
0.10	Cartwheel	X	X	0.10	Round off	⤴	R
0.20	Handspring	⤴	H	0.20	Flick Flack	⤴	F
0.20	Flyspring	⤴	FS	0.20	Tucked salto	⤴	O
0.20	Tucked salto (At start)	★ ⤴	O	0.20	Piked salto	⤴	<
0.20	Tucked salto	⤴	O	0.30	Whipback	⤴	W
0.30	Piked salto (At start)	★ ⤴	>	0.30	Straight salto	⤴	/
0.30	Piked salto	⤴	>	0.30	Tucked salto ½	⤴ 180	O1
0.30	Straight salto (At start)	★ ⤴	\	0.30	Piked salto ½	⤴ 180	<1
0.40	Straight salto	⤴	\	0.40	Tucked salto 1/1	⤴ 360	O2
0.30	Tucked salto ½	⤴ 180	O1	0.40	Straight salto ½	⤴ 180	/1
0.40	Tucked salto 1/1	⤴ 360	O2	0.50	Straight salto 1/1	⤴ 360	/2
0.40	Piked salto ½	⤴ 180	>1	0.60	Straight salto 1½	⤴ 540	/3
0.50	Straight salto ½	⤴ 180	\1	0.70	Straight salto 2/1	⤴ 720	/4
0.40	Straight salto 1/1 (At start)	★ ⤴ 360	\2	0.80	Straight salto 2½	⤴ 900	/5
0.60	Straight salto 1/1	⤴ 360	\2	0.80	Double salto tucked	⤴	OO
0.70	Straight salto 1½	⤴ 540	\3	0.90	Double salto piked	⤴	<<
0.80	Straight salto 2/1	⤴ 720	\4	1.10	Double salto straight	⤴	//
0.90	Straight salto 2½	⤴ 900	\5	1.00	Double salto tucked 1/1	⤴ 360	OO2
1.20	Double salto tucked	⤴	OO	1.20	Double salto tucked 2/1	⤴ 720	OO4
1.40	Double salto piked	⤴	>>	1.30	Double salto straight 1/1	⤴ 360	//2
1.60	Double salto straight	⤴	//	1.50	Double salto straight 2/1	⤴ 720	//4
1.30	Double salto tucked ½	⤴ 180	OO1	1.80	Double salto straight 3/1	⤴ 1080	//6
1.50	Double salto tucked 1½	⤴ 540	OO3	1.60	Triple salto tucked	⤴	OOO
1.50	Double salto piked ½	⤴ 180	>>1	1.90	Triple salto piked	⤴	<<<
1.70	Double salto straight ½	⤴ 180	//1	2.00	Triple salto tucked 1/1	⤴ 360	OOO2
1.90	Double salto straight 1½	⤴ 540	//3				
2.10	Double salto straight 2½	360 ⤴ 540	\2\3				
	★ Starting salto						











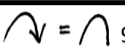

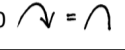
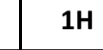

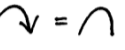

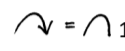
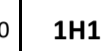

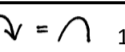

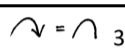
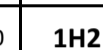

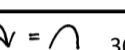

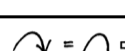
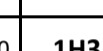

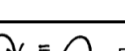
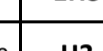





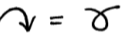

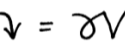

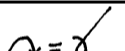

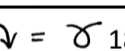

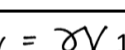

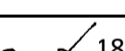

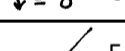

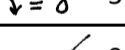













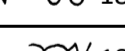

The difficulty value for other elements can be counted by adding the basic element value (marked in grey) and the additional value for twists.

Tumble - Table of Difficulty

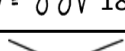
Diff value	Series 1 - Forward with tucked/piked saltos	K Code	Series 2 - Forward with straight saltos Forward	K Code	Series 3 - Back with tucked/piked saltos	K Code	Series 4 - Back with straight saltos	K Code	Series 5 - Back with two multiple saltos	K Code	Series 6 combined	K Code
0.40		HFS O				RFO						
						RF<						
0.50		HFS>						RF/				>RFO
		\HO										>RF<
0.60												>RF/
		\H>										\RF/
0.70								360 RF/2				\2RF/
0.80				180 \H/1								
				360 \2H\								
0.90				360 180 \2H\1				720 RF/4				\2RF/2
1.00				360 360 \2H\2			RFOO					
1.10				360 540 \2H\3			RF<<					\2RF/4
												\RFOO
1.20						360 RFOO2						\2RFOO
												\RF<<
1.30								RF//				\2RF<<
1.40						720 RFOO4						\2RFOO2
1.50		\HOO						360 RF//2				>RFOO4
												\2RF//
1.60		\2HOO										\2RFOO4
1.70		360 180 \2HOO1						720 RF//4				\2RF//2
		\H>>										
1.80		540 \HOO3				RFOO0						
		360 \2H>>										
1.90		360 540 \2HOO3								RF//WF00		\2RF//4
2.00				180 >H\11				1080 RF//6		RF//WF<<		
2.10				360 180 \2H\11			RF<<<		1080 RWF//6		360 RF//WF002	
2.20				540 >H\13								\2RF//6
2.30				360 540 \2H\13						720 RF//WF004		
2.40				900 >H\15						360 RF//WF//2		
2.50										360 720 RF//2WF004		
2.60										720 RF//WF//4		
2.70												
2.80										360 720 RF//2WF//4		

Appendix A4

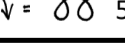
Trampet - Table of Difficulty

Diff value	Group 1 with Vaulting Table	Artistic Code	K Code	Diff value	Group 2 without Vaulting Table	Artistic Code	K Code
0.30	1/4 on 1/4 off	90  =  90	R	0.10	Tucked salto		O
0.40	Handspring 1/2 on	180  = 	1H	0.10	Piked salto		>
0.40	Handspring	 = 	H	0.20	Straight salto		\
0.50	Handspring 1/2 on 1/2 off	180  =  180	1H1	0.20	Tucked salto 1/2	 180	O1
0.50	Handspring 1/2 off	 =  180	H1	0.20	Piked salto 1/2	 180	>1
0.60	Handspring 1/2 on 1/1 off	180  =  360	1H2	0.30	Straight salto 1/2	 180	\1
0.60	Handspring 1/1 off	 =  360	H2	0.30	Tucked salto 1/1	 360	O2
0.70	Handspring 1/2 on 1 1/2 off	180  =  540	1H3	0.40	Straight salto 1/1	 360	\2
0.70	Handspring 1 1/2 off	 =  540	H3	0.50	Straight salto 1 1/2	 540	\3
0.80	Tsukahara tucked	TSU	TO	0.60	Straight salto 2/1	 720	\4
0.90	Tsukahara piked	TSU V	T<	0.70	Straight salto 2 1/2	 900	\5
1.00	Tsukahara straight	TSU /	T/	0.60	Double salto tucked		OO
1.20	Tsukahara straight 1/1 ★	TSU / 360	T/2	0.70	Double salto piked		>>
1.40	Tsukahara straight 2/1 ★	TSU / 720	T/4	0.80	Double salto straight		\
0.80	Handspring salto tucked	 = 	HO	0.70	Double salto tucked 1/2	 180	OO1
0.90	Handspring salto piked	 = 	H>	0.80	Double salto piked 1/2	 180	>>1
1.00	Handspring salto straight	 = 	H\	0.90	Double salto tucked 1 1/2	 540	OO3
0.90	Handspring salto tucked 1/2	 =  180	HO1	0.90	Double salto straight 1/2	 180	\1
1.00	Handspring salto piked 1/2	 =  180	H>1	1.10	Double salto straight 1 1/2	 540	\3
1.10	Handspring salto straight 1/2	 =  180	H\1	1.30	Double salto straight 2 1/2	 900	\5
1.30	Handspring salto straight 1 1/2	 =  540	H\3	1.60	Double salto straight 3 1/2	 1260	\7
1.50	Handspring salto straight 2 1/2	 =  900	H\5	1.50	Triple salto tucked 1/2	 180	OOO1
1.60	Double Tsukahara tucked	TSU 	TOO	1.70	Triple salto piked 1/2	 180	>>>1
1.80	Double Tsukahara piked	TSU 	T<<	1.90	Triple salto straight 1/2	 180	\1
2.00	Double Tsukahara straight	TSU 	T\	1.90	Triple salto tucked 1 1/2	 360  180	O2O1O
2.00	Double Tsukahara tucked 1/1	TSU  360	TOO2	2.30	Triple salto tucked 2 1/2	 360  360  180	O2O2O1
1.70	Handspring double tucked 1/2	 =  180	HOO1	2.80	Triple salto tucked 3 1/2	 360  360  540	O2O2O3
1.90	Handspring double piked 1/2	 =  180	H<<1				
2.10	Handspring double straight 1/2	 =  180	H\1				
2.10	Handspring dbl. tucked 1 1/2	 =  540	HOO3				
2.50	Handspring dbl. tucked 2 1/2	 =  360  540	HOO2O3				

★ TSU (tucked/straight) 360 and Kasamatsu (KAS) (tucked/straight) are judged as the same element

★ TSU (tucked/straight) 720 and Kasamatsu 360 (KAS 360) (tucked/straight) are judged as the same element



The difficulty value for other elements can be counted by adding the basic element value and the additional value for twists

Appendix A5

Tumble and Trampet - Element Recognition

1 Required Body Positions in Saltos

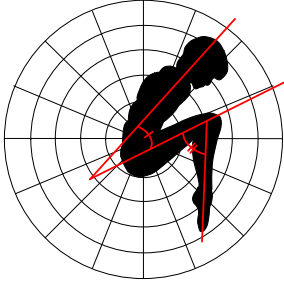
Gymnasts can rotate in tucked/pucked, piked or straight body positions as per the following definitions.

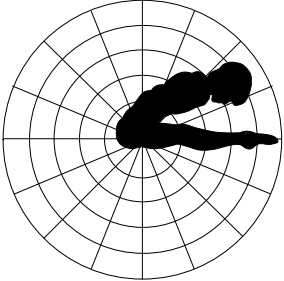
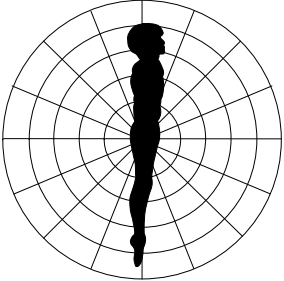
Tucked position	Pucked position	Piked position	Straight position
			
<p>In a tucked body position the knees and hips are bent and drawn towards the chest.</p> <p>Equal to or less than 135° for the hips and 135° between the thighs and the lower legs are acceptable.</p>	<p>A pucked body position is a modification of the tucked position for twisting multiple saltos.</p> <p>A pucked body position is typically 120° in the hips and 90°-120° in the knees.</p>	<p>In a piked body position the body is bent in the hips with the legs straight.</p> <p>Equal to or less than 135°* for the hips is acceptable.</p> <p>A slight bending (max 30° from straight) of the knees is accepted.</p>	<p>A straight body position is exactly 180° in both hips and knees.</p> <p>Equal to or more than 135°* for the hips are acceptable.</p>

*Body positions at exactly 135° are counted to the benefit of the team taking into account both composition deductions and difficulty. Values for body positions are only given when the gymnast clearly shows the body position in each salto. For execution deductions see Appendix A6.

All extended body positions where the knee angle is $\leq 90^\circ$ are counted as tucked (see definition of knee angle in the picture above).

In double and triple saltos with more than half twist, the tucked position may be slightly modified (opened) and is then referred to as a pucked position. The pucked position is regarded as tucked in terms of difficulty.

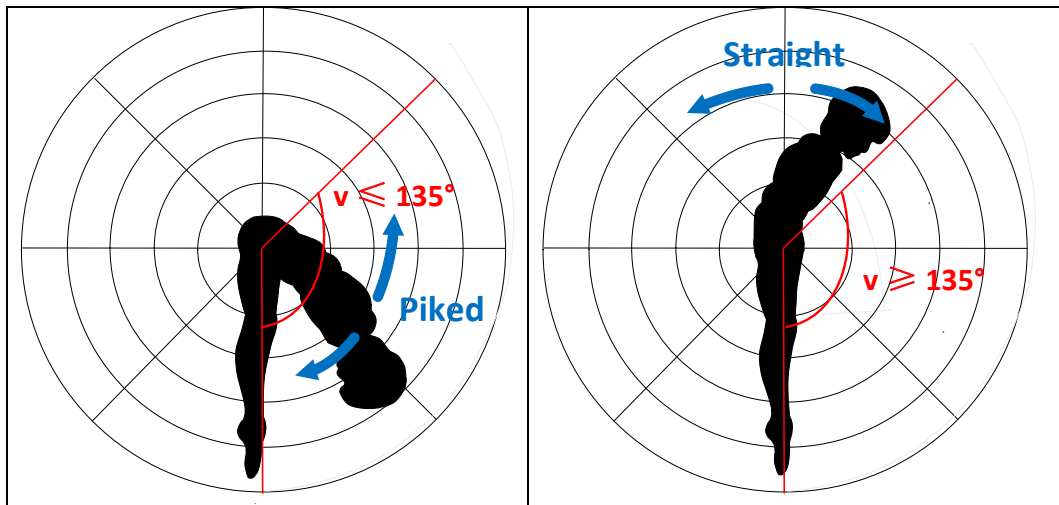

Recognition of piked (left) versus straight (right) body positions. The pictures indicate the angle at the hips. Red lines show 135° between legs and upper body.

In single forward or single backward saltos, the body position of the element should be evaluated after the take-off from 90° up to the remaining 135° before landing (see the below picture).

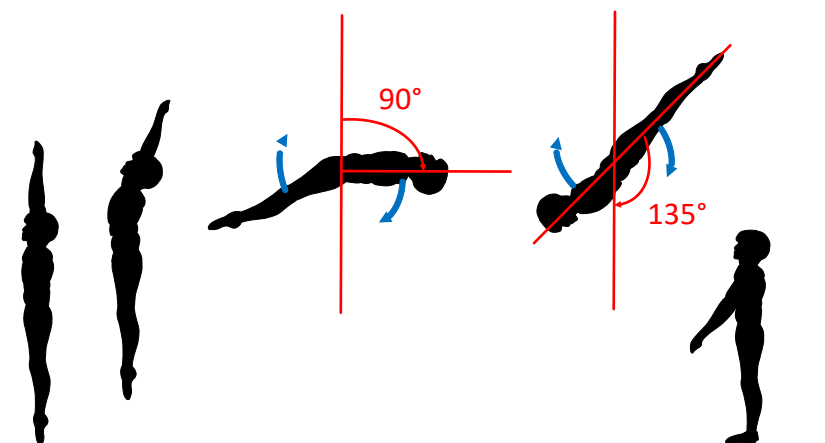

In backward multiple saltos, the body position is evaluated from 90° after the take-off and up to the remaining 180° before landing (see the below picture).

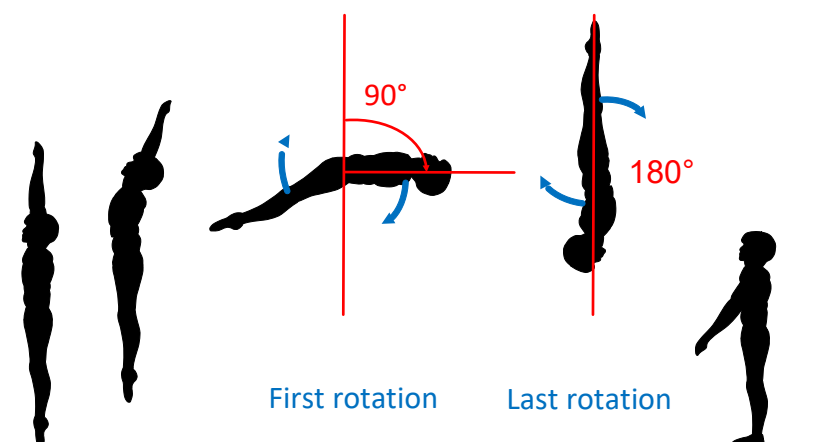

In forward multiple saltos the body position is evaluated from 135° after the take-off up to the remaining 180° before landing (see the below picture).

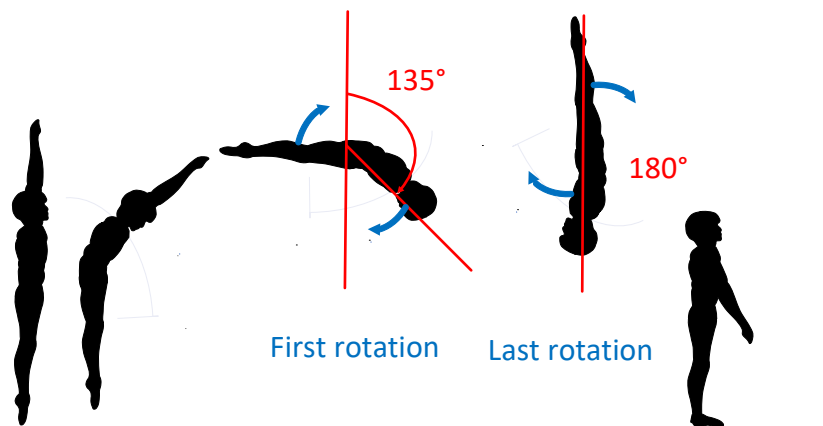

The lowest value shape shown during the flight phase defines the difficulty value of the element. A straight somersault must be shown throughout the flight phase.

2 Twisting Requirements

Additional values for twists will be accepted when rotated up to at least 45° from the nominal twist rotation. If under rotated by more than 45°, the number of credited twists is reduced to the number of completed half twists. This position is measured at the hips. Any deviation from nominal twist rotation will be deducted by the execution judges.

Note that twisting doubles and triples with less than three twists in the Team Round will require the same number of twists in each salto for each gymnast. There is 90° of tolerance for division of twists.

Tsukahara without twisting in the somersault does not fulfil the twisting requirement.

3 Double and Triple Saltos

In Trampet, double and triple saltos are counted from the trampet to landing. This means that Tsukahara, Kasamatsu and handspring salto are considered as double saltos. Double Tsukahara, double Kasamatsu and handspring double are considered as triple saltos.

4 Whipback

A whipback in Tumble is defined as a single backward salto with arched body position and performed at shoulder height or lower. An element performed higher than shoulder height and without arched body position is counted as a straight salto.

5 Elements other than saltos

For round-off, handspring, flyspring and flick-flack there must be contact from hands and feet. The limit is light contact from at least one hand and foot.

6 Tsukahara 360° and Kasamatsu

Tsukahara (TSU) 360° in tucked or straight and Kasamatsu (KAS) in tucked or straight are judged as the same elements. This also applies to TSU 720° and KAS 360°.

7 Recognition of Different Elements

Elements based on the same basic element can be counted as different if the gymnast performs with different body positions or different number of twists. This implies that in double and triple saltos an element is different even if the gymnast has changed the body position in only one salto and the difficulty value remains the same.

A double piked salto with half twist versus a double salto with half twist performed with straight body position in the first and piked in the second are different elements from a composition point of view. Although both elements will be given the same difficulty value.

In doubles and triples the number of twists in each salto also makes different elements. E.g., a double salto with full twist in and half twist out is different from a double salto with half twist in and full twist out.

When performing double and triple saltos with three or more twists the exact placement of the twists is not considered. A double straight salto with 540° twist in the first and 720° twists in the second salto is thus recognised as the same element as a double straight with 720° twists in the first and 540° in the second salto.

Appendix A6

Tumble and Trampet - General Faults and Penalties

1 Tumble and Trampet

1.1 Body Shape in Saltos (0.5)

Gymnasts can perform saltos in tucked/pucked, piked or straight shapes (as per the definitions in Appendix A5). Deductions are taken in the flight phase (after take-off phase and before preparation for landing). There are no shape deductions during take-off or preparation for landing phases within the defined ranges.

Tucked/pucked, piked and straight body positions must be performed with clear and defined body shape with feet and legs kept together and the feet and toes pointed. Both hip and knee angles must be considered for body position deductions. Arms should be close to the body in the salto. It is possible to deduct for both head and feet errors. Deductions for body position in multiple saltos are taken per element (not for each rotation of the element).

The pucked position is allowed when twisting more than 180° in multiple saltos.

Execution Faults		0.1	0.2	0.3
- Hip and knee angle faults		X	X	X
- Split/crossed legs		X	-	-
- Head errors	per gymnast/ element	X	-	-
- Feet errors		X	-	-
- Arms not close to body and axis of rotation in twists		X	-	-

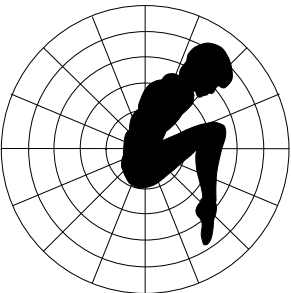
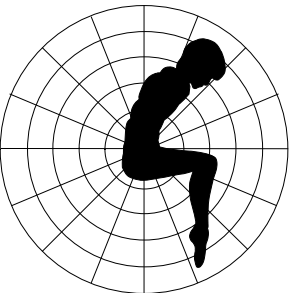
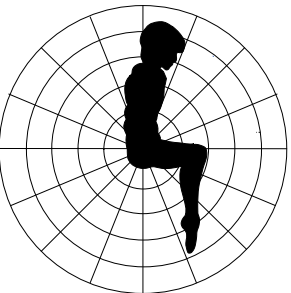
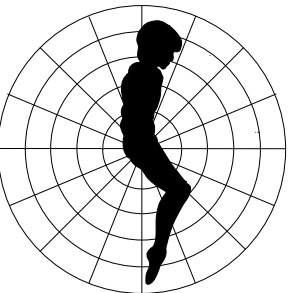
 <p>No deduction</p>	 <p>0.1 deduction</p>	 <p>0.2 deduction</p>	 <p>0.3 deduction</p>
Deduction guidelines - Tucked position			

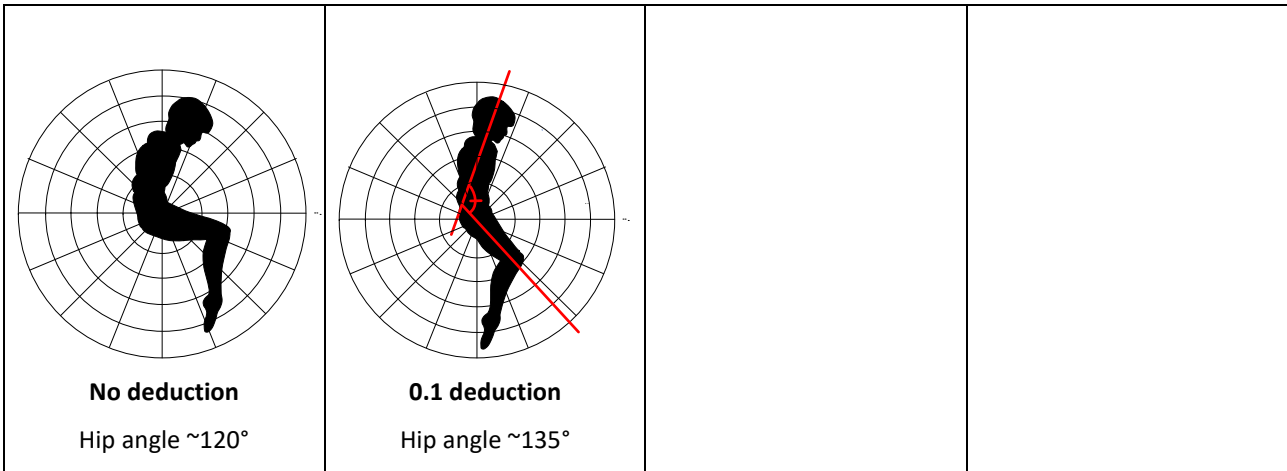

Deduction guidelines - Pucked position

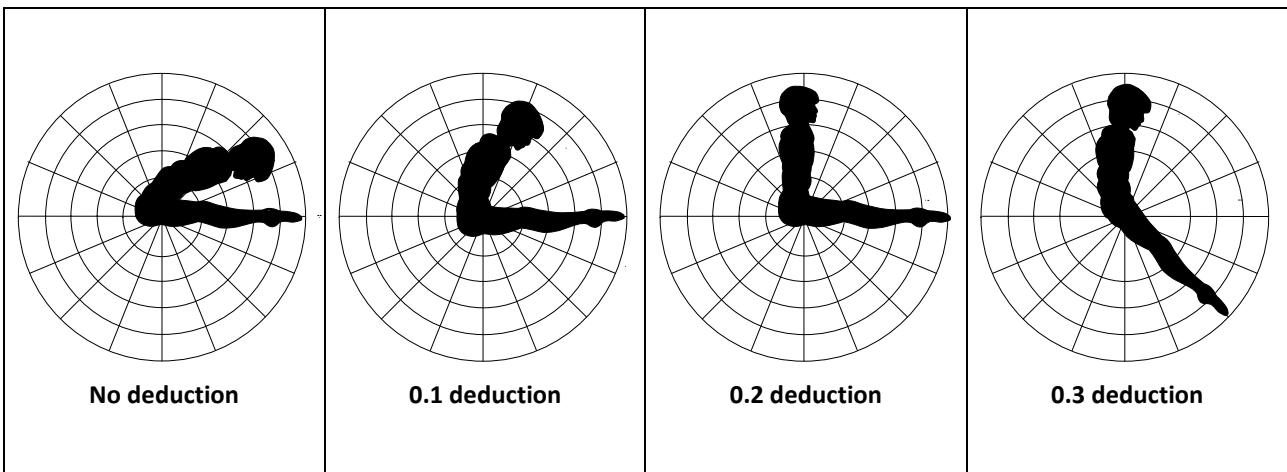

Deduction guidelines - Piked position

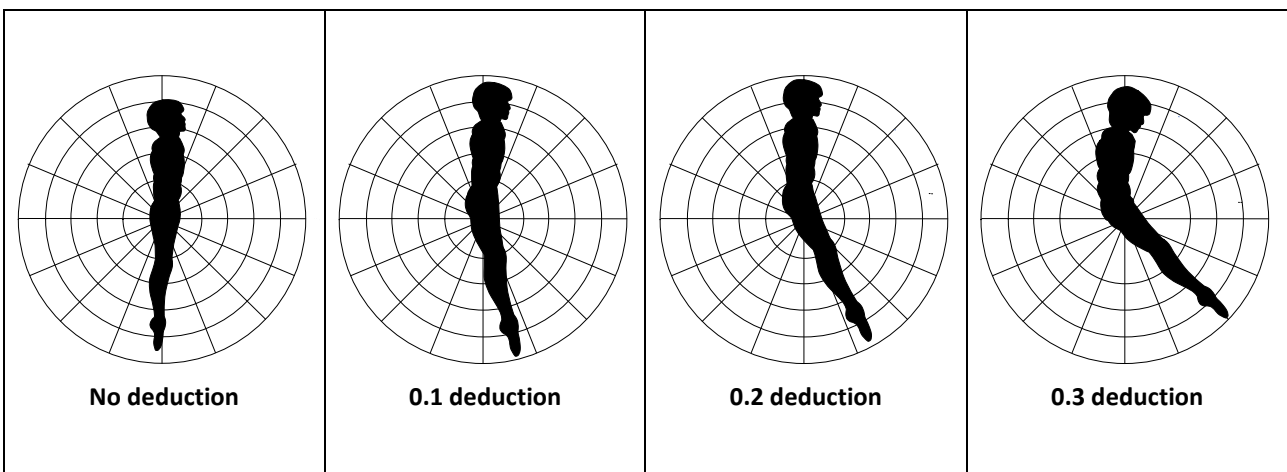

Deduction guidelines - Straight position

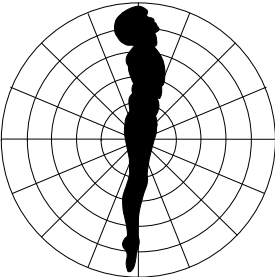
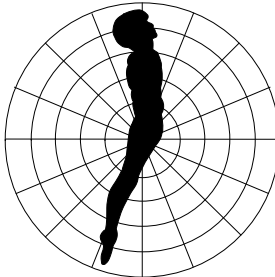
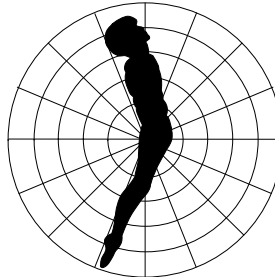
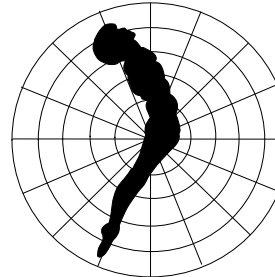
 <p>No deduction Open chest - straight line through the hips</p>	 <p>0.1 deduction</p>	 <p>0.2 deduction</p>	 <p>0.3 deduction</p>
Deduction guidelines - Straight position			

1.2 Twisting (0.5)				
The take-off phase must be clearly shown, and the twist must be completed before landing.				
Execution Faults		0.1	0.2	0.3
- Initiating the twist too early		X	X	-
- Under or over rotating the twist at the landing	per gymnast / element	X 30°- 45°		X >45°

1.3 Opening and Landing Positions in Saltos (0.5)				
Before landing, the gymnast must open the salto and show an extended body position (last element in tumble). A clear opening/extension is required from tucked and piked positions. As a guide, no more than 30° bending (relative straight) in the hip/knees are allowed.				
The opening/extension is preferably performed at horizontal (90° from vertical) or earlier. If the extended body position is reached earlier, it must be kept until at least horizontal position. Preparation for landing is allowed after horizontal.				
Twisting must be completed by horizontal.				
The body position at the landing must be upright. Some bending of the knees ($\leq 90^\circ$) and some bending at the hips ($\leq 90^\circ$) is allowed.				
Execution Faults		0.1	0.2	0.3
- Late opening (>90° - 135° from vertical) or early opening but not kept until horizontal position		X	-	-
- Opening after 135° from vertical or no opening before landing	per gymnast	-	X	-

Execution Faults		0.1	0.2	0.3
- Twisting not completed at horizontal		X	-	-
- Hips/knees bending >90° up to a deep squat		X	X	X

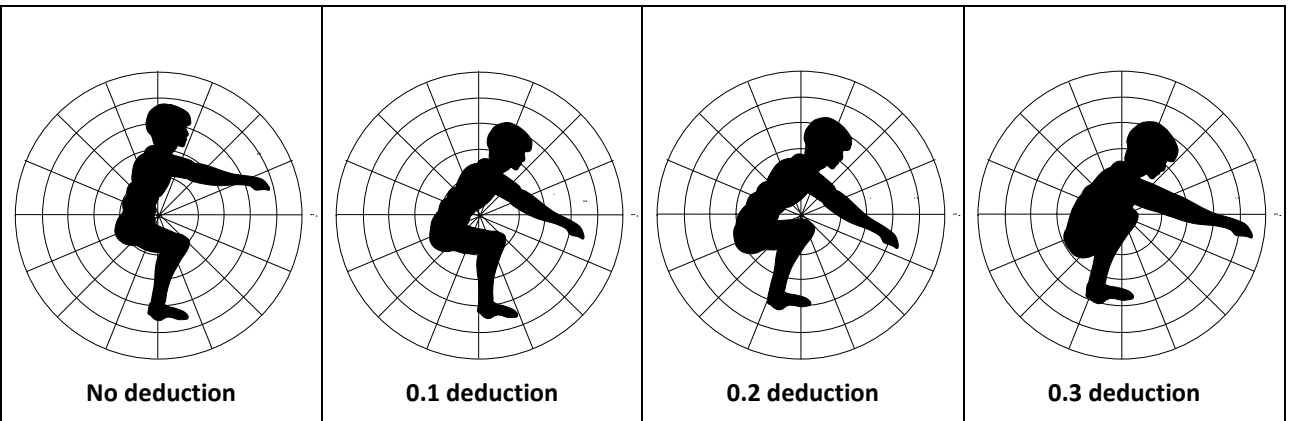
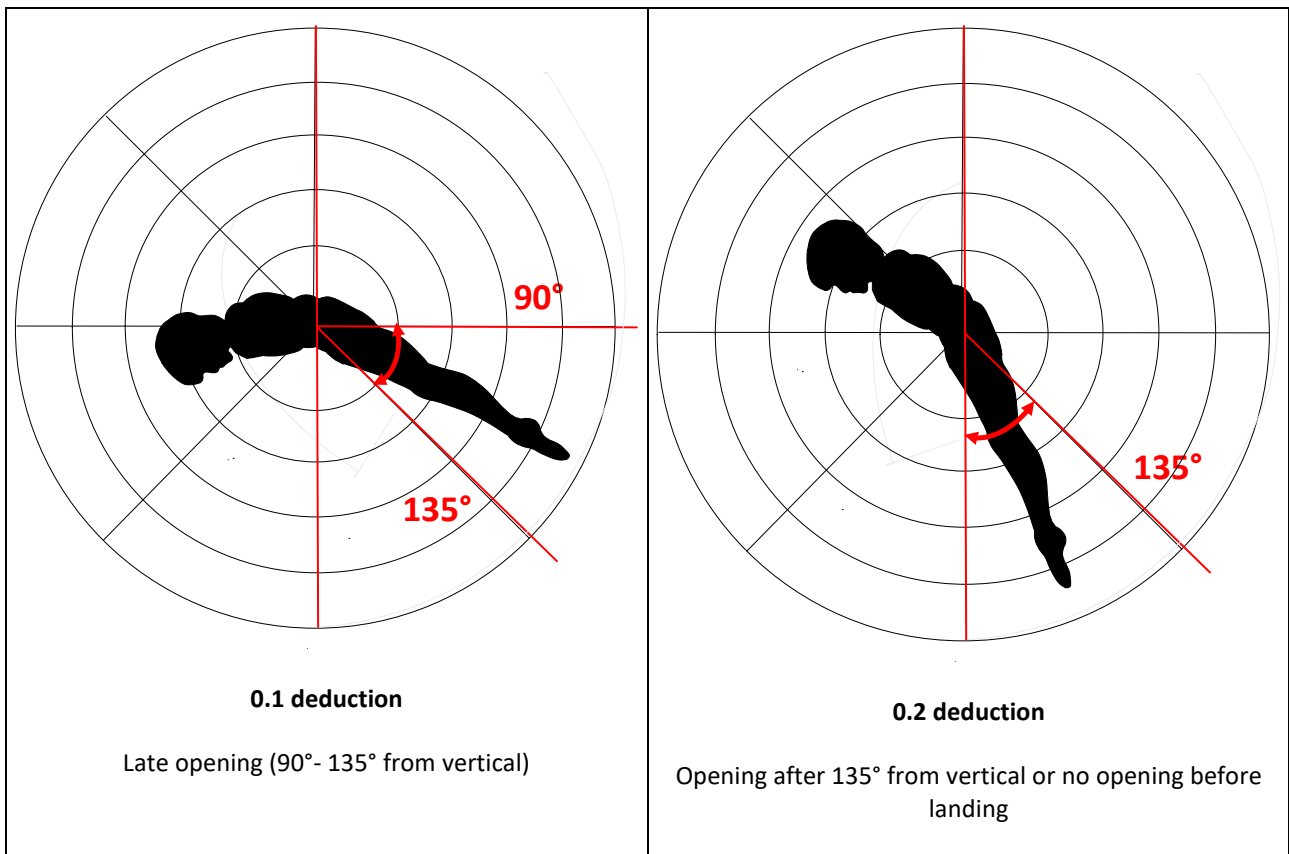

Deduction guidelines when bending in the hips and the knees at the landing

1.4 Landing the Last Element inside the Landing Zone (0.3)

Gymnast should land the last element on tumble in the landing area.
 The first point of contact with the landing area should be inside the coloured landing zone (1.5 x 3.0 m).
 If the landing area outside the landing zone is touched with any part of the body as first point of contact, there will be a small deduction.
 If the first point of contact is completely outside the landing zone, there will be a large deduction.
 It is allowed to step outside the landing zone after the initial contact with the landing area.

Execution Faults		0.1	0.2	0.3
- Touching outside the landing zone	per gymnast/ each time	X	-	-
- Landing outside the landing zone / not landing last element on tumble in the landing area		-	-	X

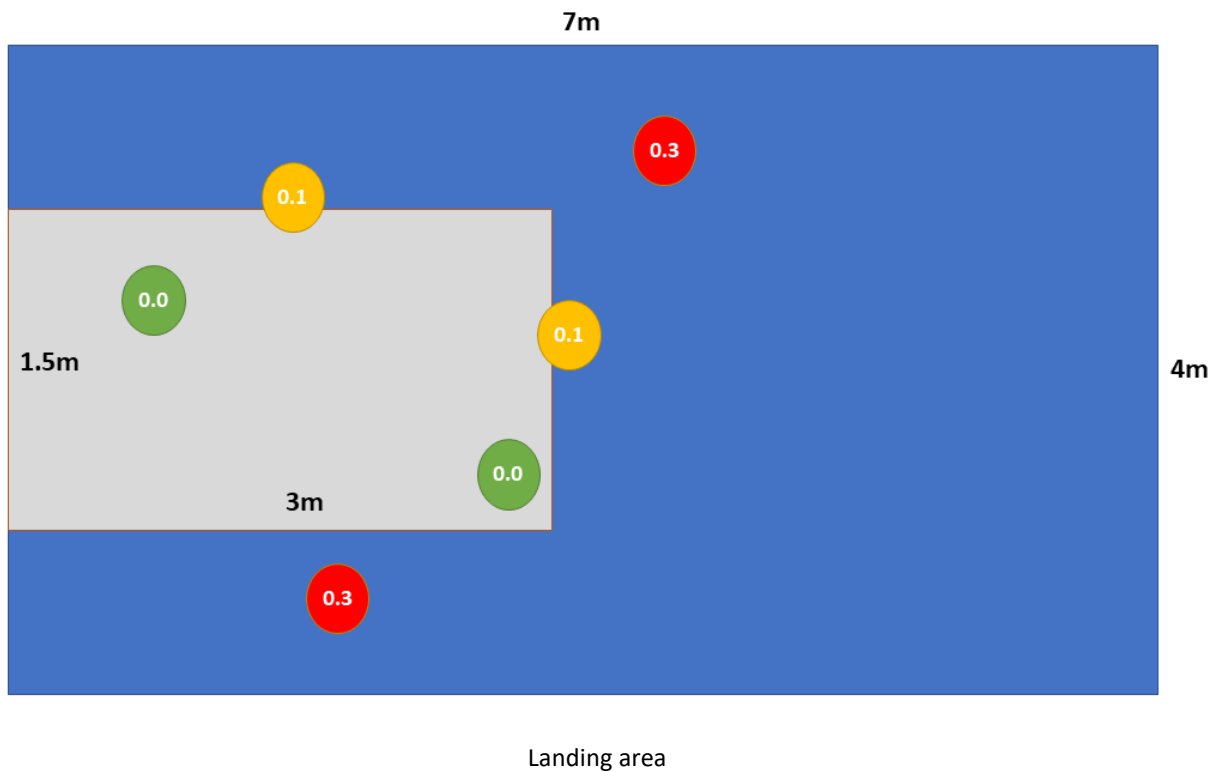

1.5 Control in Landing (1.0)				
<p>The landing must be controlled with both feet at the same time but may continue moving in the direction of tumble (stream), under control.</p> <p>To gain control after landing it is allowed to take one small step ($\leq 60^\circ$ leg separation) or a small rebound from extended legs. Further steps (once balanced) to exit the landing zone are accepted without deduction.</p> <p>Movement of other body parts (e.g. none supportive arm movement) are not deductible. There is no requirement to place feet together after control has been attained.</p> <p>Loss of Control MINOR - one large step $> 60^\circ$ leg separation, or large rebound jump (knees flex to maintain upright position), or not landing with both feet at the same time.</p> <p>Loss of Control MODERATE - multiple steps or corrections to gain control</p> <p>Loss of Control MAJOR - light touching of the mat or apparatus with hands/knees without supportive weight.</p> <p>Falls receive the highest deductions. Deduction is based on whether falling was due to over rotation or under rotation.</p>				
Execution faults		0.1	0.2	0.3 or more
- Loss of control MINOR	per gymnast	X	-	-
- Loss of control MODERATE		-	X	-
- Loss of control MAJOR		-	-	0.5
- Fall – over rotation		-	-	0.8
- Fall – under rotation		-	-	1.0

1.6 Coaches' Actions (1.5)				
<p>A compulsory coach standing in is only there to react in case of dangerous situations, not to draw attention to themselves. The coach is there to avoid injury to the gymnasts and not to stop gymnasts from falling over.</p> <p>All supportive actions that touch the gymnast are deductible.</p>				
Execution Faults		0.1	0.2	0.3 or more
- Support	per gymnast	-	-	1.0
- Not acting in a dangerous situation		-	-	1.5

1.7 Streaming (0.1)				
Streaming (time between each gymnast) must be even between all gymnasts. At least two gymnasts must be moving at the same time. On Tumble the next gymnast is not allowed to start the first element until the previous gymnast has completed the last element.				
Execution Faults		0.1	0.2	0.3
- Irregular streaming/ lack of streaming	per gymnast each time	X	-	-

1.8 Jogging Back Together Between Rounds (0.4)				
Gymnasts must jog back to the run up after round 1 and 2. They must return together.				
Execution Faults		0.1	0.2	0.3 or more
- Not jogging back	per team for each round	-	-	0.4
- Not returning together		-	-	

1.9 Special Deductions				
1.9.1 Running through (3.0)				
In case a gymnast runs through without performing any valid elements there will be a deduction. No other execution faults or special deductions are taken for the gymnast.				
Execution Faults		0.1	0.2	0.3 or more
- Running through	per gymnast	-	-	3.0

1.9.2 Wrong Number of Gymnasts (3.0 per missing/extra gymnast)				
In case there are too few or too many gymnasts performing or there are not three male and three female gymnasts in a mixed team, there will be a deduction. No other execution faults or special deductions are taken for the extra gymnast.				
Execution Faults		0.1	0.2	0.3 or more
- More than 6 or less than 6 gymnasts	per wrong number of gymnasts	-	-	3.0
- More or less than 3 men and less or more than 3 women in the mixed team		-	-	
Examples: 2 men and 4 women will be deducted $1 \times 3.0 = 3.0$ (one woman should be replaced by a man) 5 men and 1 woman will be deducted $2 \times 3.0 = 6.0$ (two men should be replaced by two women) 3 men and 2 women will be deducted $1 \times 3.0 = 3.0$ (one gymnast/woman is missing)				

2 Tumble

2.1 Body Shape for Elements other than Saltos (0.4)				
Elements like round off, flic flack and handspring (not the saltos) must be performed with a clear and defined body shape, with feet and legs kept together when appropriate, as well as feet pointed. It is possible to deduct for both head and feet errors.				
Execution Faults		0.1	0.2	0.3
- Arms / shoulder, hip, and knee angle faults	per gymnast / element	X	X	-
- Split/crossed legs, head, or feet errors		X	-	-
- One hand support		X	-	-
2.2 Momentum (0.3)				
The gymnast must keep the momentum until the final landing. The kinetic energy can be transferred between rotation, speed, and height. Loss of momentum is deducted from minor to major. The maximum deduction 0.3 is applied when the gymnast is almost standing still.				
Execution Faults		0.1	0.2	0.3
- Loss of momentum	per gymnast	X	X	X
2.3 Height of the Final Salto Forwards (0.2)				
As a guide, the equivalent height of the element would be measured at the top of the head when the gymnast is upside down, at the highest point during the performance of a straight salto. For double salto the same height applies for the centre of gravity of the gymnast.				
The height of the salto should be no lower than the shoulder height of the standing gymnast when the body is upside down at the highest point. The standing height is measured from the top of the landing mat.				
Execution Faults		0.1	0.2	0.3
- Too Low	per gymnast / element	-	X	-

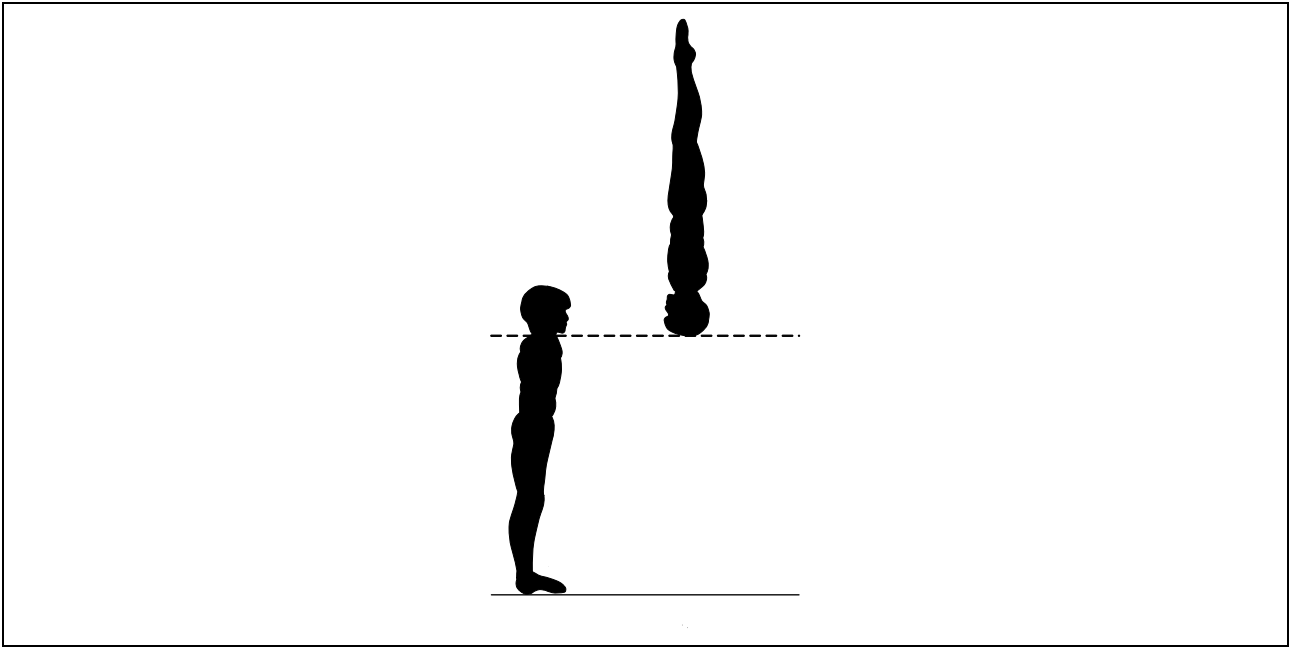

2.4 Height of the Final Salto Backwards (0.2)

As a guide, the equivalent height of the element would be measured at the top of the head when the gymnast is upside down, at the highest point during the performance of a single straight salto. For double and triple saltos the same height applies for the centre of gravity of the gymnast.

The height of the salto should be no lower than the top of the standing gymnast's head when the body is upside down at the highest point. The standing height is measured from the top of the landing mat.

Execution Faults		0.1	0.2	0.3
- Too Low	per gymnast	-	X	-

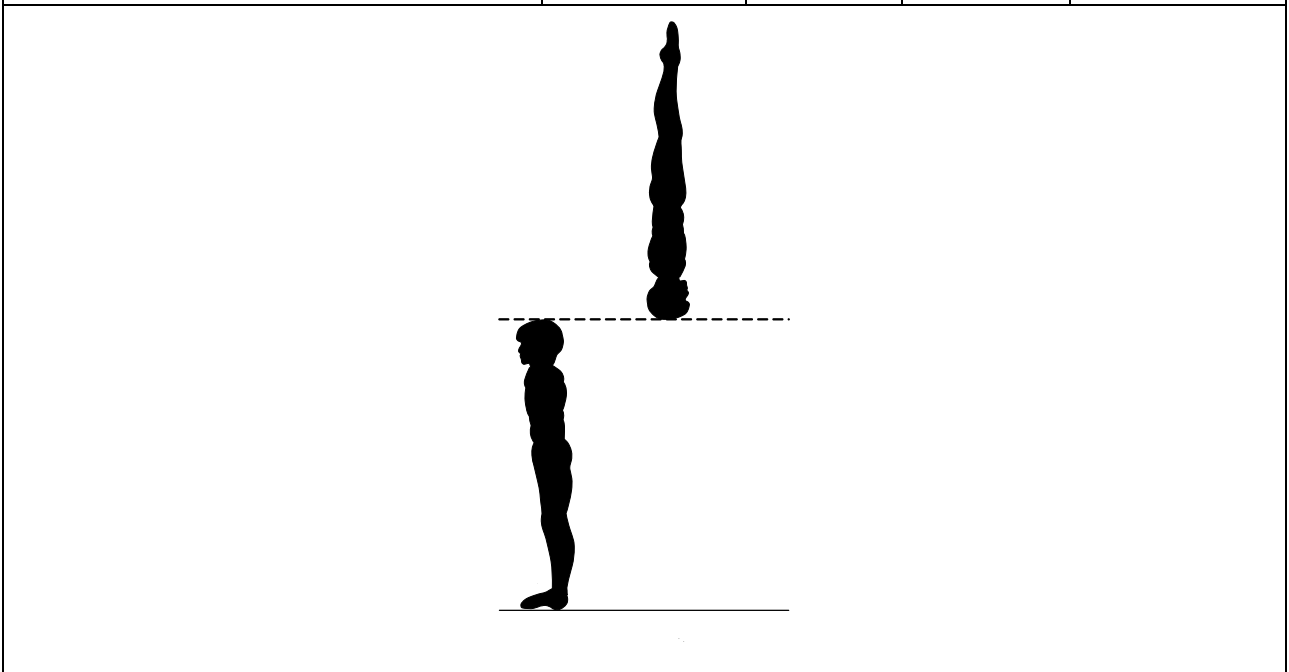

3 Trampet

3.1 Contact with the Vault (0.6)

Gymnasts must touch the table with both hands, leaving** the vaulting table in an extended body position through the vertical*, and use the vaulting table to achieve a visible lift off the table.

When leaving the table, the gymnast should be vertical (-45° - +30° from the vertical line through the point of contact), and in an extended body position (knee, hips, shoulder angle >135°) with straight arms (>135° in the elbows).

There are no requirements for body position before touching the vaulting table (first flight).

* How to assess the vertical:

A vertical line from the point of hand contact establishes 'the vertical' with 45° to the trampet side of the vault and 30° to the landing zone side. This creates a cone shaped zone about the point of hand contact.

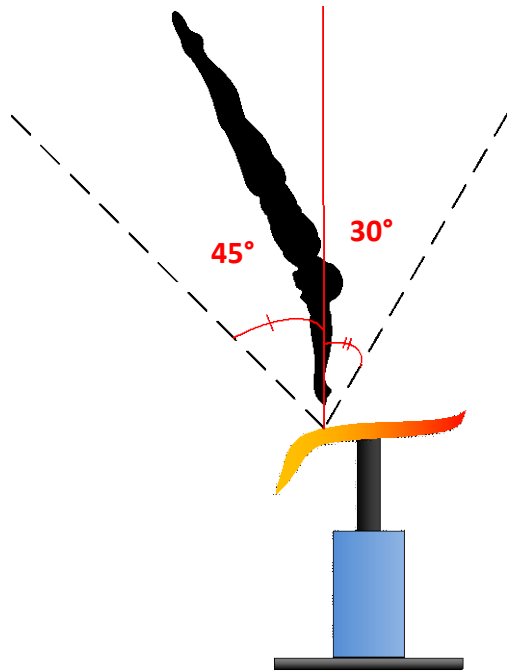

Assessing the vertical and angles of tolerance

** How to assess the position upon leaving the vault:

At the point where the hands leave the vault, a straight line is assessed from shoulders to knees. This angle of leaving the vault should be within angle of tolerance about the vertical*.

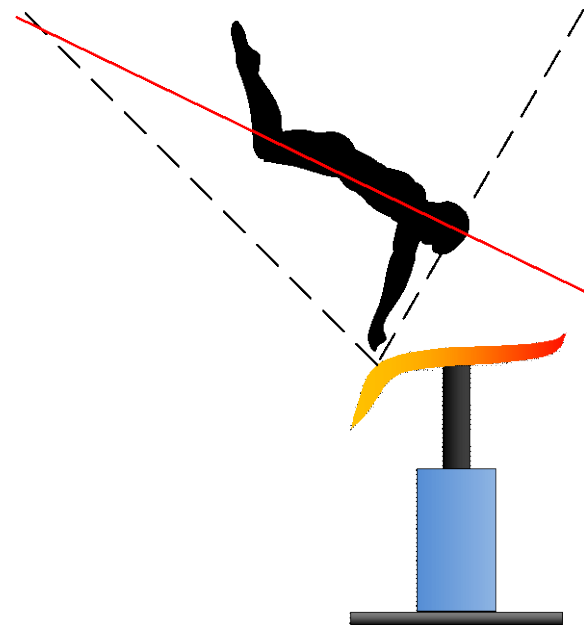

Angle when leaving the vault

Execution Faults		0.1	0.2	0.3 or more
- Leaving the vaulting table too early (angle when leaving outside the 45° to the trampet side)	per gymnast	X	-	-
- Leaving the vaulting table too late (angle when leaving outside the +30° to the landing zone side)		-	X	-
- Not leaving the vaulting table with extended body position (>135°)		X	X	-
- Not having straight arms when leaving vaulting table		-	X	-
- Touching the vaulting table with only one hand		-	-	0.6

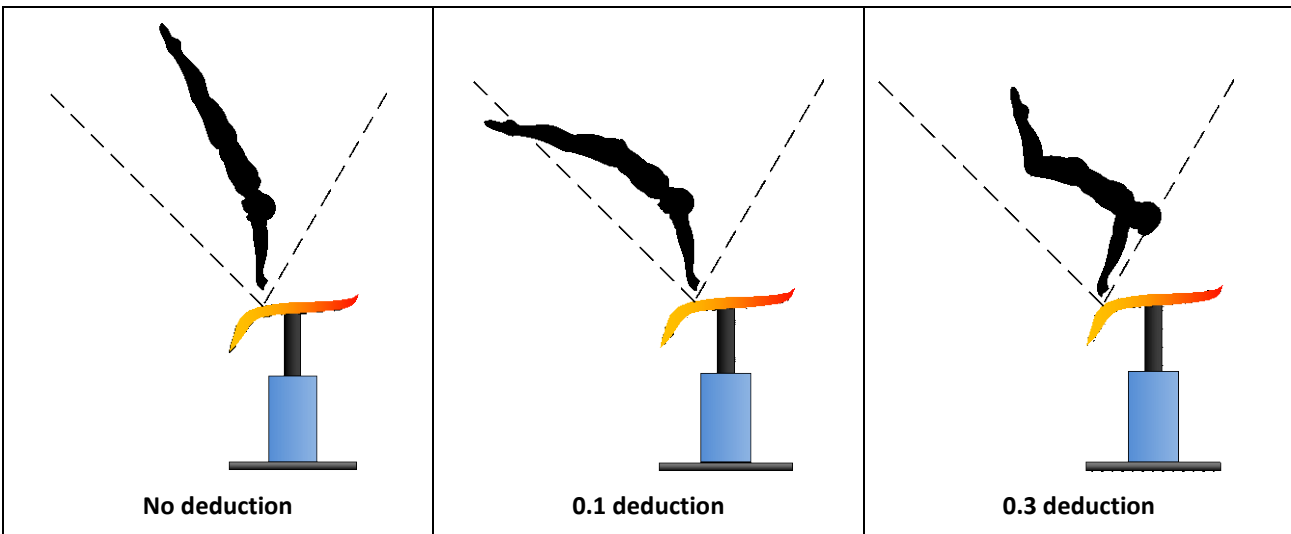

Deduction guidelines for Contact with the Vault - Handspring

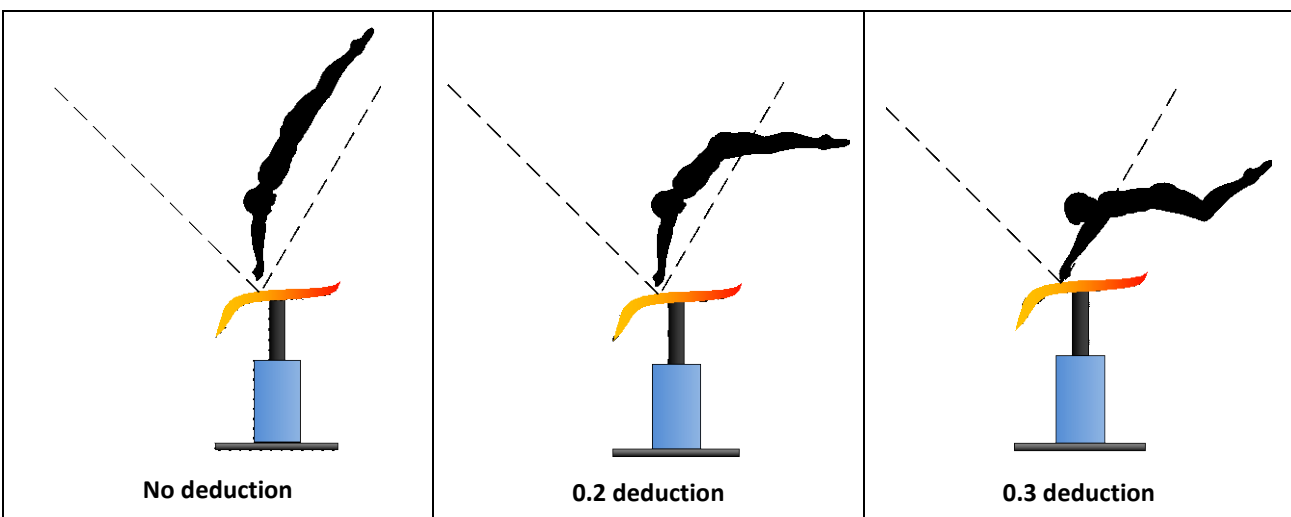

Deduction guidelines for Contact with the Vault - Tsukahara

3.2 Height of the Salto (0.2)

As a guide, the equivalent height of the element would be measured at the top of the head when the gymnast is upside down, at the highest point during the performance of a single straight salto. For double and triple saltos the same height applies for the centre of gravity of the gymnast.

The height of the salto should be no lower than the height of the standing gymnast plus one head above when the body is upside down at the highest point. The standing height is measured from the top of the landing mat.

The height requirement is valid for elements both with and without the vaulting table.

Execution Faults		0.1	0.2	0.3
- Too Low	per gymnast	-	X	-

